

INLINE MIXED-FLOW FANS



EN

Turbo EC

USER'S MANUAL

 **BLAUBERG**

CONTENTS

Delivery set.....	5
Brief description	5
Operation guidelines	5
Designation key.....	6
Installation	7
Connection to power mains	9
Operation algorithm.....	12
Maintenance.....	14
Troubleshooting.....	15
Storage and transportation regulations.....	16
Manufacturer's warranty.....	17

This user's manual is a main operating document intended for technical, maintenance, and operating staff. The manual contains information about purpose, technical details, operating principle, design, and installation of the Turbo EC unit and all its modifications.

Technical and maintenance staff must have theoretical and practical training in the field of ventilation systems and should be able to work in accordance with workplace safety rules as well as construction norms and standards applicable in the territory of the country.

This unit is not intended for use by persons (including children) with reduced physical, sensory or mental capabilities, or lack of experience and knowledge, unless they have been given supervision or instruction concerning use of the unit by a person responsible for their safety.

Children should be supervised to ensure that they do not play with the unit.

This appliance can be used by children aged from 8 years and above and persons with reduced physical, sensory or mental capabilities or lack of experience and knowledge if they have been given supervision or instruction concerning use of the appliance in a safe way and understand the hazards involved.

Cleaning and user maintenance shall not be done by children without supervision. Children shall not play with the appliance.

Connection to the mains must be made through a disconnecting device, which is integrated into the fixed wiring system in accordance with the wiring rules for design of electrical units, and has a contact separation in all poles that allows for full disconnection under overvoltage category III conditions.

If the supply cord is damaged, it must be replaced by the manufacturer, its service agent, or similarly qualified persons in order to avoid a safety hazard.

CAUTION: In order to avoid a safety hazard due to inadvertent resetting of the thermal cut-out, this unit must not be supplied through an external switching device, such as a timer, or connected to a circuit that is regularly switched on and off by the utility.

Ensure that the unit is switched off from the supply mains before removing the guard.

Precautions must be taken to avoid the back-flow of gases into the room from the open flue of gas or other fuel-burning appliances.

The appliance may adversely affect the safe operation of appliances burning gas or other fuels (including those in other rooms) due to back flow of combustion gases. These gases can potentially result in carbon monoxide poisoning. After installation of the unit the operation of flued gas appliances should be tested by a competent person to ensure that back flow of combustion gases does not occur.

All operations described in this manual must be performed by qualified personnel only, properly trained and qualified to install, make electrical connections and maintain ventilation units.

Do not attempt to install the product, connect it to the mains, or perform maintenance yourself.

This is unsafe and impossible without special knowledge.

Disconnect the power supply prior to any operations with the unit.

All user's manual requirements as well as the provisions of all the applicable local and national construction, electrical, and technical norms and standards must be observed when installing and operating the unit. Disconnect the unit from the power supply prior to any connection, servicing, maintenance, and repair operations.

Connection of the unit to power mains is allowed by a qualified electrician with a work permit for the electric units up to 1000 V after careful reading of the present user's manual.

Check the unit for any visible damage of the impeller, the casing, and the grille before starting installation. The casing internals must be free of any foreign objects that can damage the impeller blades.

While mounting the unit, avoid compression of the casing! Deformation of the casing may result in motor jam and excessive noise.

Misuse of the unit and any unauthorised modifications are not allowed.

Transported air must not contain any dust or other solid impurities, sticky substances, or fibrous materials.

Do not use the unit in a hazardous or explosive environment containing spirits, gasoline, insecticides, etc.

Do not close or block the intake or extract vents in order to ensure the efficient air flow.

Do not sit on the unit and do not put objects on it.

The information in this user's manual was correct at the time of the document's preparation.

The Company reserves the right to modify the technical characteristics, design, or configuration of its products at any time in order to incorporate the latest technological developments.

Never touch the unit with wet or damp hands.

Never touch the unit when barefoot.

BEFORE INSTALLING ADDITIONAL EXTERNAL DEVICES, READ THE RELEVANT USER MANUALS.



**THE PRODUCT MUST BE DISPOSED SEPARATELY AT THE END OF ITS SERVICE LIFE.
DO NOT DISPOSE THE UNIT AS UNSORTED DOMESTIC WASTE.**

DELIVERY SET

Fan	— 1 pc.
Screws and dowels	— 4 pcs.
User's manual	— 1 pc.
Packing box	— 1 pc.

BRIEF DESCRIPTION

The product described herein is a mixed-flow inline fan for supply or exhaust ventilation of premises heated. The fan is designed for connection to \varnothing 100, 125, 150, 160, 200, 250 and 315 mm air ducts.

The fan is equipped with an energy-efficient and high-performance electronically commutated motor (EC motor) and with a built-in speed controller.

An external control unit can be connected to the fan (purchased separately).

The fan design is constantly being improved, thus some models may be slightly different from those described in this manual.

OPERATION GUIDELINES

The fan is rated for connection to single-phase AC 220-240 V/50 (60) Hz power mains.

The fan is rated for continuous operation.

Air motion direction in the system must match the pointer on the fan casing.

Hazardous parts access and water ingress protection rating is IPX4.

The fan is rated for operation at the ambient temperature ranging from +1 °C up to +40 °C.

Transported air temperature must not exceed +40 °C. Temperature up to +60 °C is allowed for a short time (up to 15 minutes).

The ventilator is rated as a class I or class II (depending on the installed electric motor, see the sticker on the product body).

DESIGNATION KEY

Turbo

EC

100

GI1

Options:

T: timer

TW: timer with 4-pin plug with cable

GI1: speed controller with an electronic thermostat and a temperature sensor integrated inside an air duct. Temperature-based operation logic

G1: speed controller with an electronic thermostat and an outdoor temperature sensor fixed on a 4 m cable. Temperature-based operation logic

FR1: integrated smooth speed controller

Spigot diameter [mm]

Electronically commutated motor

Inline fan

To comply with the ErP 2018 regulation, a local demand controller must be used.

INSTALLATION

The fan is suitable both for horizontal or vertical mounting on the floor, on the wall or on the ceiling. While mounting the fan provide extra protection against water ingress, such as:

1. For the top mounting: install an outer protecting hood above.
2. For any mounting position: connect an air duct on both sides of the fan.

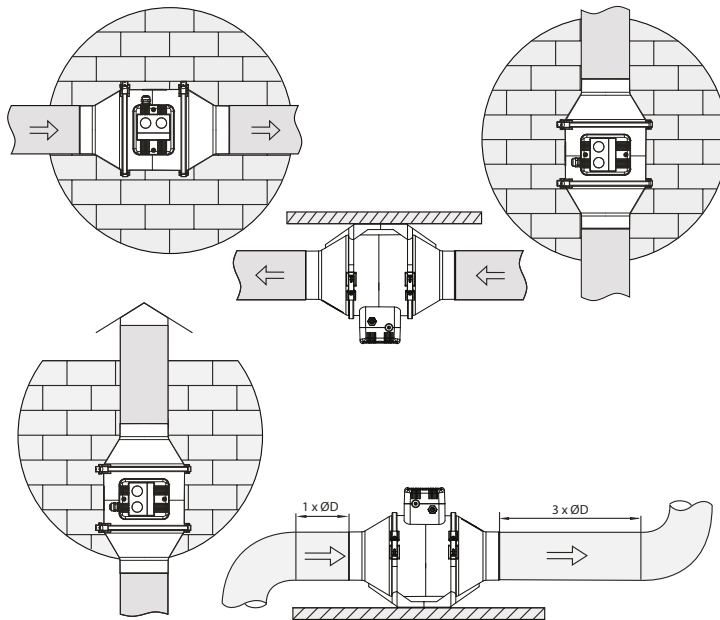

The mounting sequence

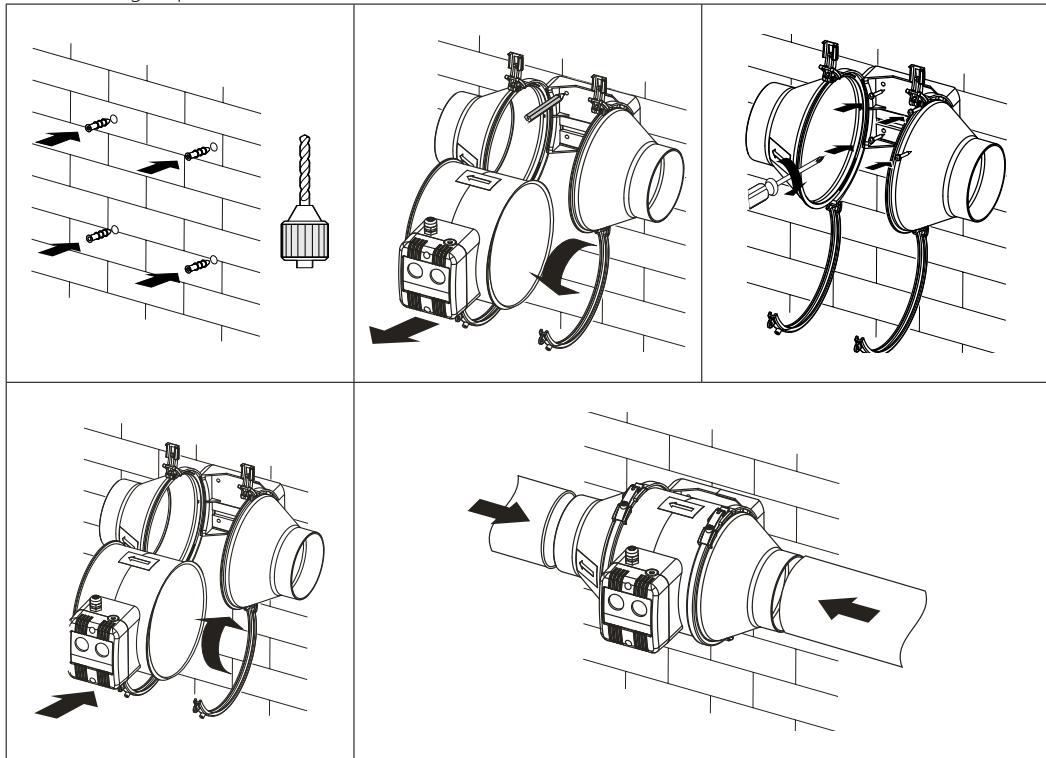

CONNECTION TO POWER MAINS

Use copper wires for all the electric connections!

To access the terminals, loosen the screws and remove the cover.

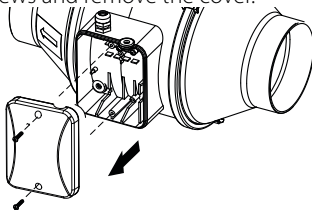

The connection must be made in accordance with the external wiring diagram.

Turbo EC

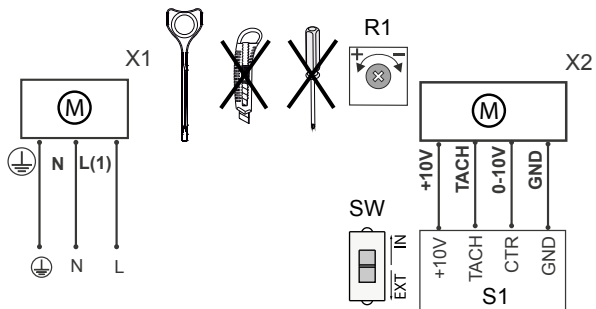

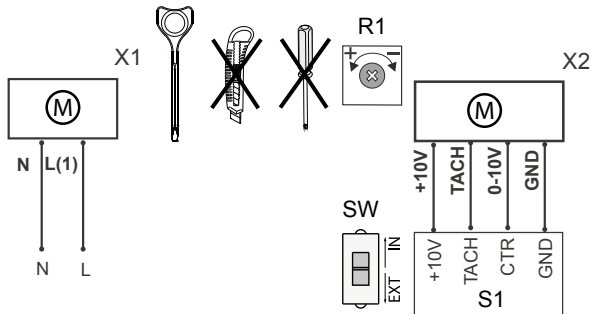

X1	terminal block for 230 V/ 50-60 Hz power mains
X2	terminal block for connection of an external speed controller
S1	external speed controller 0-10 V
R1	internal speed controller
SW	DIP switch

Turbo ECTW

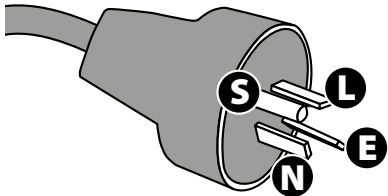

L - phase, brown; N - zero, blue; E - ground, yellow/green; S - timer control, white.

Turbo ECT

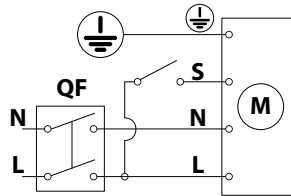

L - phase; N - zero; S - timer control line; QF - circuit breaker

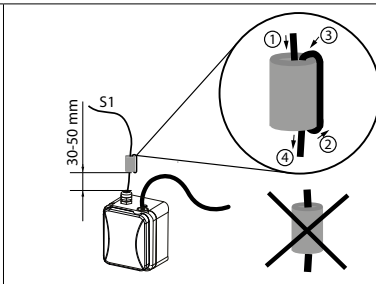
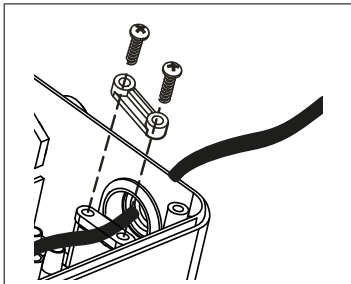

CAUTION! Route the signal cable through the ferrite core as tightly as possible.

The signal cable must be laid in accordance with the relevant regulations.

For Turbo EC 100/125/150 fans, it is possible to connect an external control unit (to be ordered separately) using an unshielded cable with a WE 742 700 51 ferrite core (to be ordered separately) or similar, with an impedance of not less than 500 ohms at a frequency of 100 MHz (with two turns of the cable).

OPERATION ALGORITHM

The motor is controlled by sending of an external control signal from 0 to 10 V to the X2 terminal block or by the R1 internal speed controller. Control method selection is carried out by means of the SW DIP switch:

– **DIP switch in IN position.** The control signal is set by the R1 internal speed controller, which allows to turn the fan on and off, smoothly adjust the speed of the fan motor (air flow) in the range from minimum to maximum speed.

Rotations are controlled from minimum (extreme right position) to maximum (extreme left position). When rotating clockwise, the rotations decrease.

– **DIP switch in EXT position.** The control signal is set by the S1 external control unit.

The **Turbo EC G1/GI1** fan is equipped with an electronic module **TSC** (speed controller with an electronic thermostat) for automatic fan speed control (air flow) depending on the air temperature.

The terminal compartment incorporates 2 control knobs:

- presetting speed
- setting electric thermostat threshold value

The thermostat operation indicator is located on the fan cover.

To set the thermostat threshold, rotate the thermostat control knob clockwise to increase or counter-clockwise to decrease the temperature set point.

To set the fan speed (air flow), rotate the speed control knob in the same way.

CAUTION! In case of short-term effects of electrostatic disturbance on the **Turbo EC G1/GI1** fan, the fan may stop. To restore it, turn the fan off and on with the speed controller, which is located on the fan casing.

The **Turbo ECT(W)** fan is equipped with a timer set to a 12-minute shutdown delay. When power is applied to the control terminal, the fan turns on. When the control terminal is de-energized, the fan exhausts the delay time and turns off.

Turbo EC G1

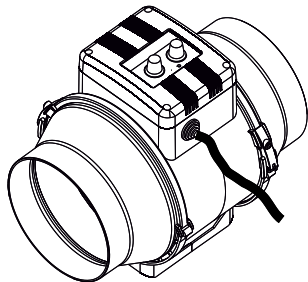

Turbo EC G1

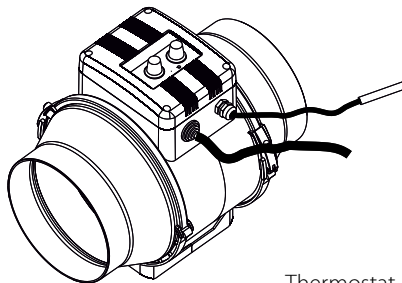

Speed control knob

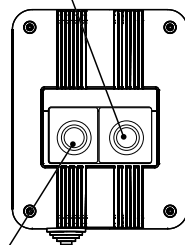

Thermostat control knob



Turbo EC FR1/T(W)

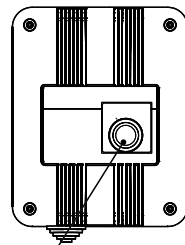
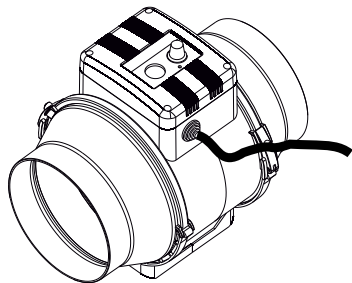

Speed control knob



MAINTENANCE

Clean the product surfaces regularly (once in 6 months) from dust and dirt. Disconnect the fan from power mains prior to any maintenance operations. To clean the fan, use a soft cloth or a brush wetted in a mild detergent solution. Avoid water ingress to electrical components. Wipe the unit surfaces dry after cleaning.

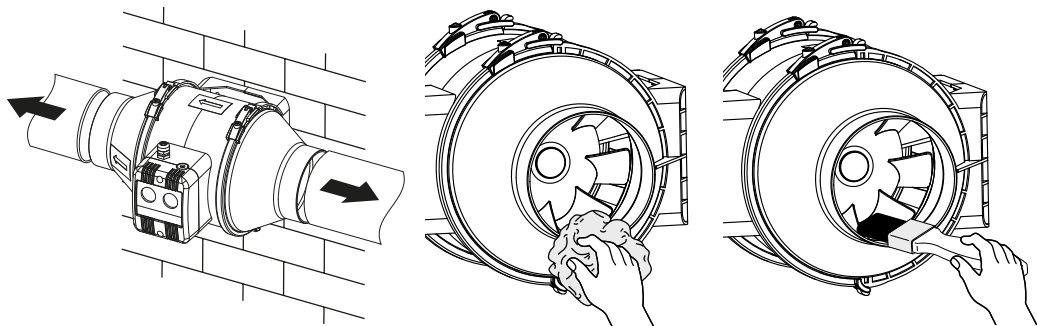

TROUBLESHOOTING

Problem	Possible reasons	Troubleshooting
When the unit is connected to power mains, the fan does not rotate and does not respond to any controls.	No power supply.	Make sure the power supply line is connected correctly, otherwise troubleshoot the connection error.
	Internal connection fault.	Contact the Seller.
Low air flow.	The ventilation system is clogged.	Clean the ventilation system.
Increased noise, vibration.	The impeller is clogged.	Clean the impeller.
	The fan is not secured well or is not mounted properly.	Troubleshoot the installation error.
	The ventilation system is clogged.	Clean the ventilation system.

STORAGE AND TRANSPORTATION REGULATIONS

- Store the unit in the manufacturer's original packaging box in a dry closed ventilated premise with temperature range from +5 °C to +40 °C and relative humidity up to 70 %.
- Storage environment must not contain aggressive vapors and chemical mixtures provoking corrosion, insulation, and sealing deformation.
- Use suitable hoist machinery for handling and storage operations to prevent possible damage to the unit.
- Follow the handling requirements applicable for the particular type of cargo.
- The unit can be carried in the original packaging by any mode of transport provided proper protection against precipitation and mechanical damage. The unit must be transported only in the working position.
- Avoid sharp blows, scratches, or rough handling during loading and unloading.
- Prior to the initial power-up after transportation at low temperatures, allow the unit to warm up at operating temperature for at least 3-4 hours.

MANUFACTURER'S WARRANTY

The product is in compliance with EU norms and standards on low voltage guidelines and electromagnetic compatibility. We hereby declare that the product complies with the provisions of Electromagnetic Compatibility (EMC) Directive 2014/30/EU of the European Parliament and of the Council, Low Voltage Directive (LVD) 2014/35/EU of the European Parliament and of the Council and CE-marking Council Directive 93/68/EEC. This certificate is issued following test carried out on samples of the product referred to above.

The manufacturer hereby warrants normal operation of the unit for 24 months after the retail sale date provided the user's observance of the transportation, storage, installation, and operation regulations. Should any malfunctions occur in the course of the unit operation through the Manufacturer's fault during the guaranteed period of operation, the user is entitled to get all the faults eliminated by the manufacturer by means of warranty repair at the factory free of charge. The warranty repair includes work specific to elimination of faults in the unit operation to ensure its intended use by the user within the guaranteed period of operation. The faults are eliminated by means of replacement or repair of the unit components or a specific part of such unit component.

The warranty repair does not include:

- routine technical maintenance
- unit installation/dismantling
- unit setup

To benefit from warranty repair, the user must provide the unit, the user's manual with the purchase date stamp, and the payment paperwork certifying the purchase. The unit model must comply with the one stated in the user's manual. Contact the Seller for warranty service.

The manufacturer's warranty does not apply to the following cases:

- User's failure to submit the unit with the entire delivery package as stated in the user's manual including submission with missing component parts previously dismantled by the user.
- Mismatch of the unit model and the brand name with the information stated on the unit packaging and in the user's manual.
- User's failure to ensure timely technical maintenance of the unit.
- Damage to the unit casing and internal components caused by the user.
- Redesign or engineering changes to the unit.

- Replacement and use of any assemblies, parts and components not approved by the manufacturer.
- Unit misuse.
- Violation of the unit installation regulations by the user.
- Violation of the unit control regulations by the user.
- Unit connection to power mains with a voltage different from the one stated in the user's manual.
- Unit breakdown due to voltage surges in power mains.
- Discretionary repair of the unit by the user.
- Unit repair by any persons without the manufacturer's authorization.
- Expiration of the unit warranty period.
- Violation of the unit transportation regulations by the user.
- Violation of the unit storage regulations by the user.
- Wrongful actions against the unit committed by third parties.
- Unit breakdown due to circumstances of insuperable force (fire, flood, earthquake, war, hostilities of any kind, blockades).
- Missing seals if provided by the user's manual.
- Failure to submit the user's manual with the unit purchase date stamp.
- Missing payment paperwork certifying the unit purchase.



FOLLOWING THE REGULATIONS STIPULATED HEREIN WILL ENSURE A LONG AND TROUBLE-FREE OPERATION OF THE UNIT



USER'S WARRANTY CLAIMS SHALL BE SUBJECT TO REVIEW ONLY UPON PRESENTATION OF THE UNIT, THE PAYMENT DOCUMENT AND THE USER'S MANUAL WITH THE PURCHASE DATE STAMP

Turbo EC _____

Quality Inspector's Stamp _____

Seller _____
(name and stamp of the seller)

Purchase Date _____

Manufacturer: Ventilation Systems LLC,
Ukraine, Kyiv, 1 M. Kotsyubynskoho Street

Address of production facilities:
Ukraine, Kyiv Region, Fastiv District, Boyarka, 36 Sobornosti Street

